

JIS ANSI/ASME/ASTM DIN/ISO

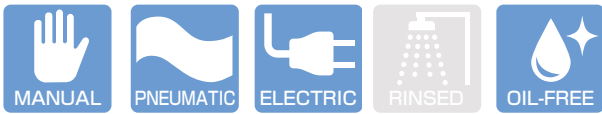

Operating Temperature(°C)

PVC	0 ~ 50	PP	- 20 ~ 80
HT-CPVC	0 ~ 90	PVDF	- 20 ~ 100

ESLON BALL VALVE TYPE M

Feature

- Left hand screw on ball holder prevents screw loose and ensures perfect sealing of the valve when union nut is loosened.
- Full port in all size. No pressure loss at full opened position by nominal size of inner diameter.
- Keep water quality by little obstructed design in flow path. Compared with the conventional type (non-mount type), light-weight & compactness.
- It's possible to install an actuator on to the valve body directly.

⚠ Important Notes

- Gasifying, volatile, or evaporating fluid such as hydrogen peroxide and sodium hypochlorite might rise inner pressure of valve and burst the valve. Please contact us concerning such risk. Gas relief type of customized ball valve which has relief orifice on the ball is available.
- Do not use for the fluid containing slurry, solid, sediment, or crystallized fluid. Or for those kinds of fluid, strainer should be used in upstream.

Maximum Working Pressure - Temperature Rating

Body material : PVC

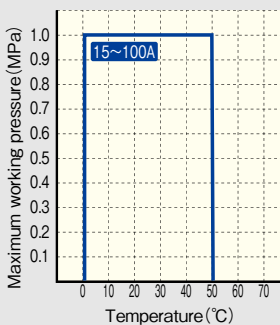

Body material : HT · CPVC

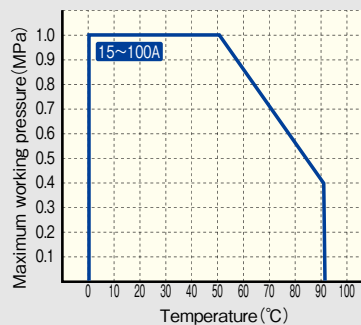

Body material : PP

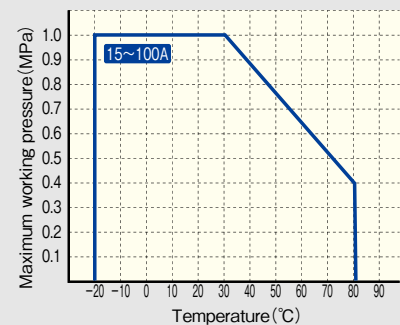

Body material : PVDF

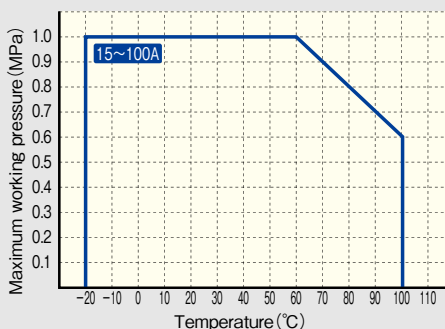
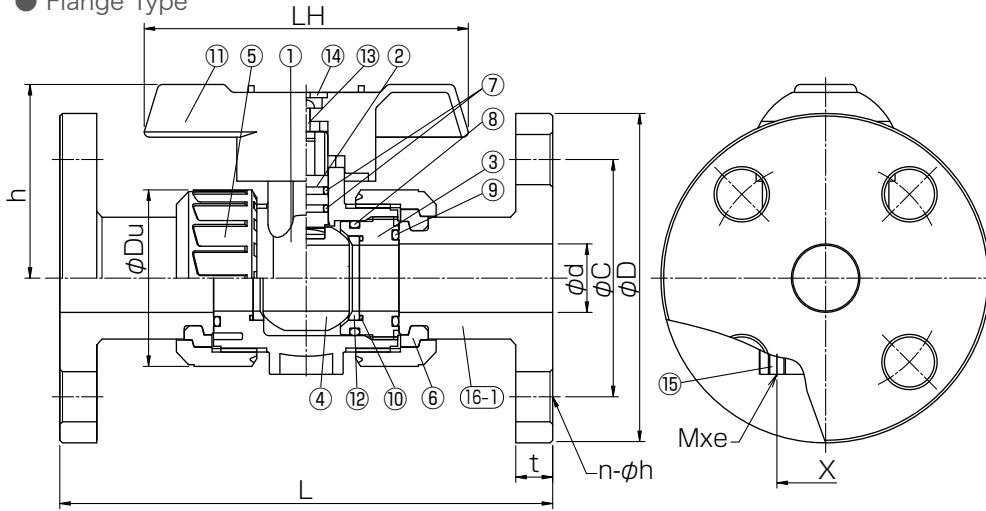
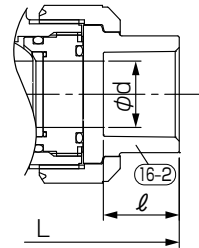

Figure (Flange Type · TS Socket Type · Thread Type · Butt Type)

● Flange Type



● TS Socket Type (PVC, HT, CPVC)



● Thread Type (PVC, PVDF)

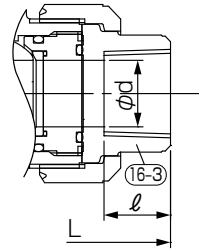

● Butt Type (PVDF)

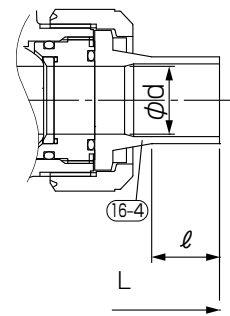

Parts List

No.	Part Name	QTY	Material/Color	No.	Part Name	QTY	Material/Color
1	Body	1	● PVC	14	Handle Cap	1	ABS
2	Stem	1	● HT (JIS:Brown)	15	Insert Nut	2	C3604
3	Ball holder	1	● CPVC	16-1	Flange	2	● PVC ● HT ● CPVC ● PP ● PVDF
4	Ball	1	(ANSI-DIN:Gray)				
5	Union nut	2	● PP ● PVDF	16-2	TS Socket	2	● PVC ● HT ● CPVC
6	Set ring	2					
7	Stem O-ring	2		16-3	Threaded	2	● PVC ● PVDF ● PP ● PVDF
8	Ball holder O-ring	1	● EPDM				
9	Union O-ring	2	● FKM	16-4	Butt Spigot Type	2	● PVC ● PVDF ● PE
10	Ball seat O-ring	2					
11	Handle	1	ABS				
12	Ball Seat	2	PTFE				
13	Screw	1	SUS304				

Size

Size		FIXING Insert Nut					Flange														
A	B	φd	h	LH	φDu	X	Mxe	PVC,HT		PP,PVDF		JIS10K			ANSI			DIN			
								φD	φC	n-φh	t	φD	φC	n-φh	t	φD	φC	n-φh	t		
15	1/2	15	53	95	49	27	M5x8	143	95	70	4-15	14	89	60.5	4-16	11.5	95	65	4-14	11	
20	3/4	20	62	95	59	32	M5x8	172	100	75	4-15	14	98	70.0	4-16	13.0	105	75	4-14	12	
25	1	25	76	123	67	37	M5x8	187	125	90	4-19	14	108	79.5	4-16	14.5	115	85	4-14	14	
32	1 1/4	32	84	123	81	42	M5x8	190	135	100	4-19	16	117.5	89.0	4-16	16.0	140	100	4-18	15	
40	1 1/2	40	114	158	98	57	M6x10	212	140	105	4-19	16	127	98.5	4-16	17.5	150	110	4-18	16	
50	2	50	120	158	120	67	M6x10	234	155	120	4-19	20	152	120.5	4-19	19.5	165	125	4-18	18	
65	2 1/2	65	153	211	150	81	M6x10	259	257	175	140	19	22	178	139.5	4-20	22.5	185	145	4-18	22
80	3	80	171	240	186	99.7	M8x10	304	301	185	150	8-19	22	191	152.5	4-20	24.0	200	160	8-18	23
100	4	100	202	290	228	119.7	M8x10	372	367	210	175	8-19	24	229	190.5	8-20	24.0	220	180	8-18	23

Size		TS Socket						Thread											
A	B	JIS		ASTM		DIN		JIS,DIN(Rc)				ANSI(NPT)				DIN(Rp)			
		PVC,HT,CPVC						PVC		PVDF		PVC		PVDF		PVC		PVDF	
		L	ℓ	L	ℓ	L	ℓ	L	ℓ	L	ℓ	L	ℓ	L	ℓ	L	ℓ	L	ℓ
15	1/2	109	22	103	22.22	92	16	97	18	99	20	97	18	99	99	97	18	99	99
20	3/4	132	25	119	25.4	107	19	117	18	116	22	117	18	116	116	117	18	116	116
25	1	143	29	133	28.58	121	22	128	23	136	24	128	23	136	136	128	23	136	136
32	1 1/4	166	32	147	31.75	137	26	146	23	148	25	146	23	148	148	146	23	148	148
40	1 1/2	175	35	171	34.93	161	31	163	25	169	28	163	25	169	169	163	25	169	169
50	2	203	38	188	38.1	189	38	188	30	196	30	188	30	196	196	188	30	196	196
65	2 1/2	259	61	211	44.45	211	44	227	32	227	32	212	32	212	227	212	32	212	227
80	3	311	64	262	47.63	263	51	278	37	278	37	261	37	261	278	261	37	261	278
100	4	390	84	315	57.15	315	61	330	45	330	45	315	45	315	330	315	45	315	330

Size		Butt Spigot				Socket welding		Weight(kg/unit)											
A	B	DIN		DIN		DIN		Flange				Socket		Thread		Spigot			
		PP,PVDF		PE		PP		PVC		HT,CPVC		PP		PVDF		PP		PVDF	
		L	ℓ	L	ℓ	L	ℓ	PVC	HT,CPVC	PP	PVDF	PVC	HT,CPVC	PVC	PVDF	PP	PVDF		
15	1/2	143	30	210	65	103	17.5	12.0	0.4	0.4	0.3	0.5	0.2	0.2	0.2	0.2	0.1	0.2	
20	3/4	152	24	220	65	114	19.0	13.0	0.6	0.6	0.4	0.7	0.3	0.3	0.3	0.3	0.2	0.4	
25	1	161	24	237	70	126	21.0	14.5	0.9	0.9	0.5	1.0	0.4	0.4	0.4	0.5	0.3	0.5	
32	1 1/4	167	25	258	75	141	23.5	18.0	1.2	1.2	0.7	1.3	0.6	0.6	0.6	0.6	0.4	0.7	
40	1 1/2	190	24	292	80	162	26.5	16.0	1.8	1.8	1.2	2.0	1.2	1.2	1.2	1.3	0.7	1.3	
50	2	216	28	325	90	185	30.5	20.0	2.7	2.7	1.7	3.1	1.7	1.8	1.7	2.0	1.1	1.9	
65	2 1/2	208	23	363	100	204	34.0	21.0	4.7	4.7	3.2	5.7	3.5	3.7	3.5	4.1	2.3	4.0	
80	3	301	45	424	105	264	37.0	26.5	7.3	7.6	5.0	9.1	6.2	6.8	6.2	7.5	4.3	7.6	
100	4	340	43	478	110	317	41.0	31.5	12.5	13.0	8.1	15.5	11.5	12.3	11.5	13.5	7.2	13.3	